

1

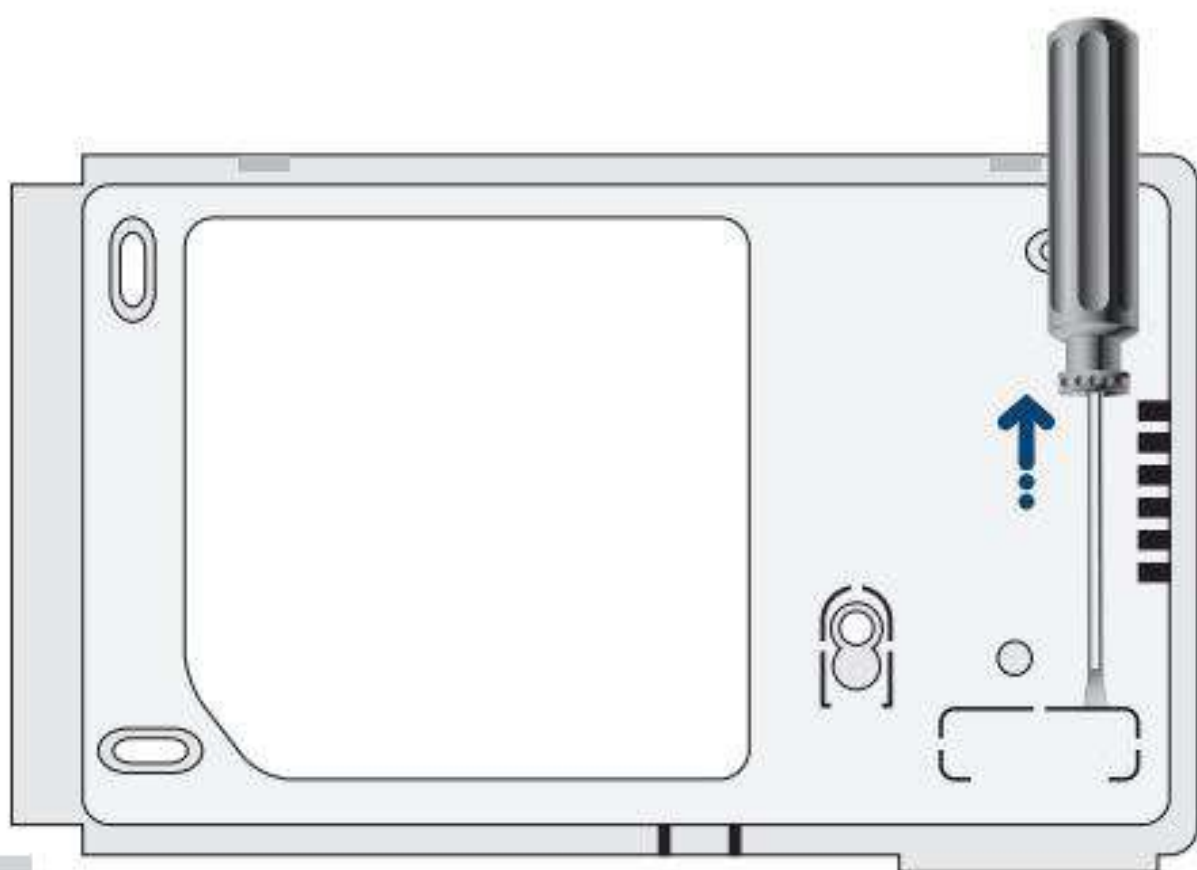

2

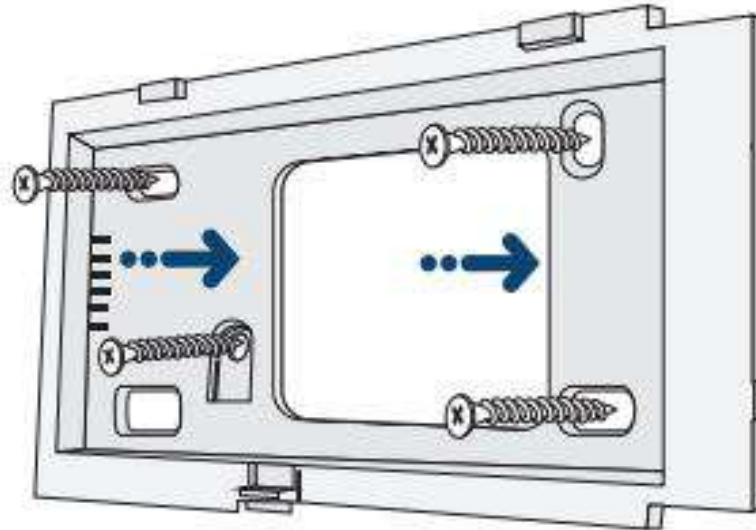

3

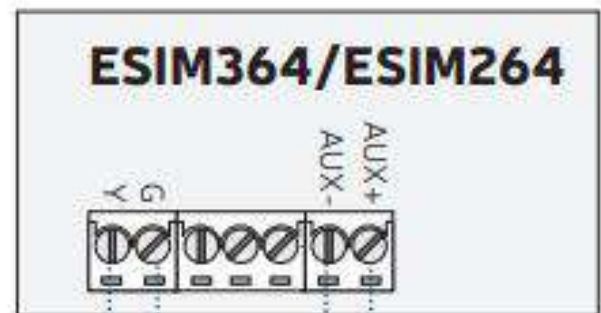
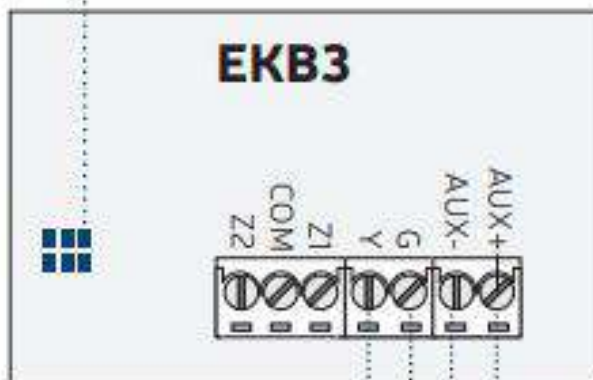
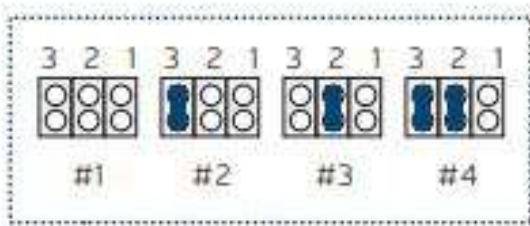

4

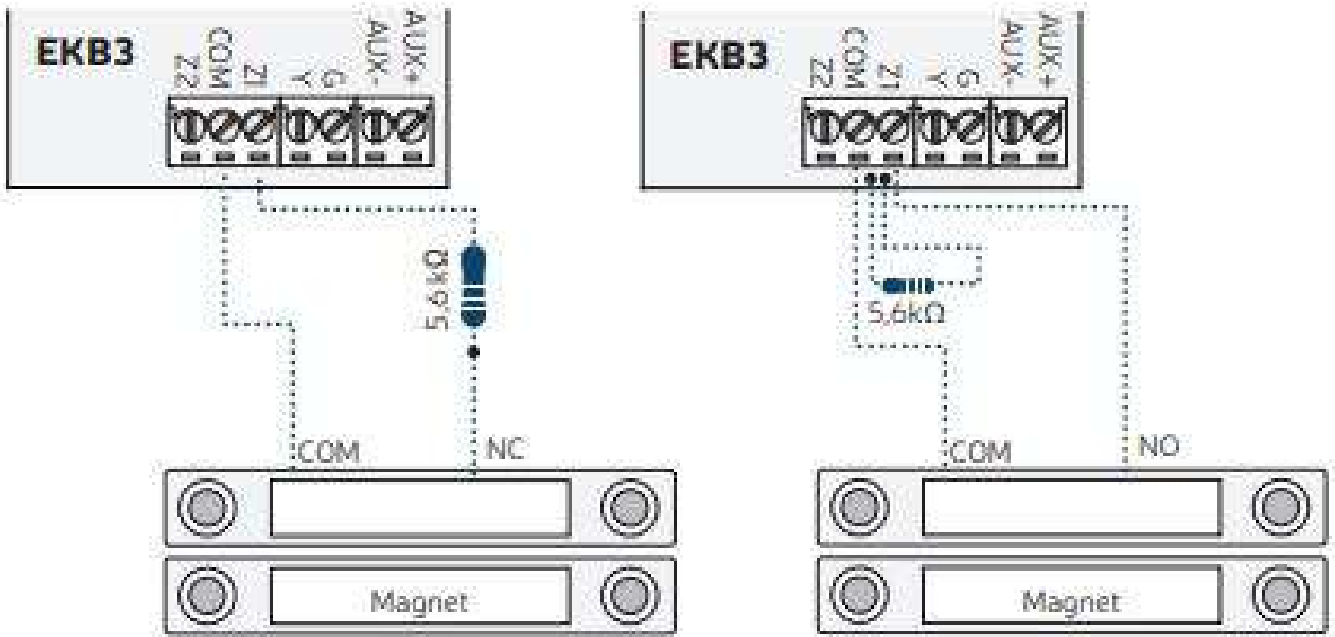

5

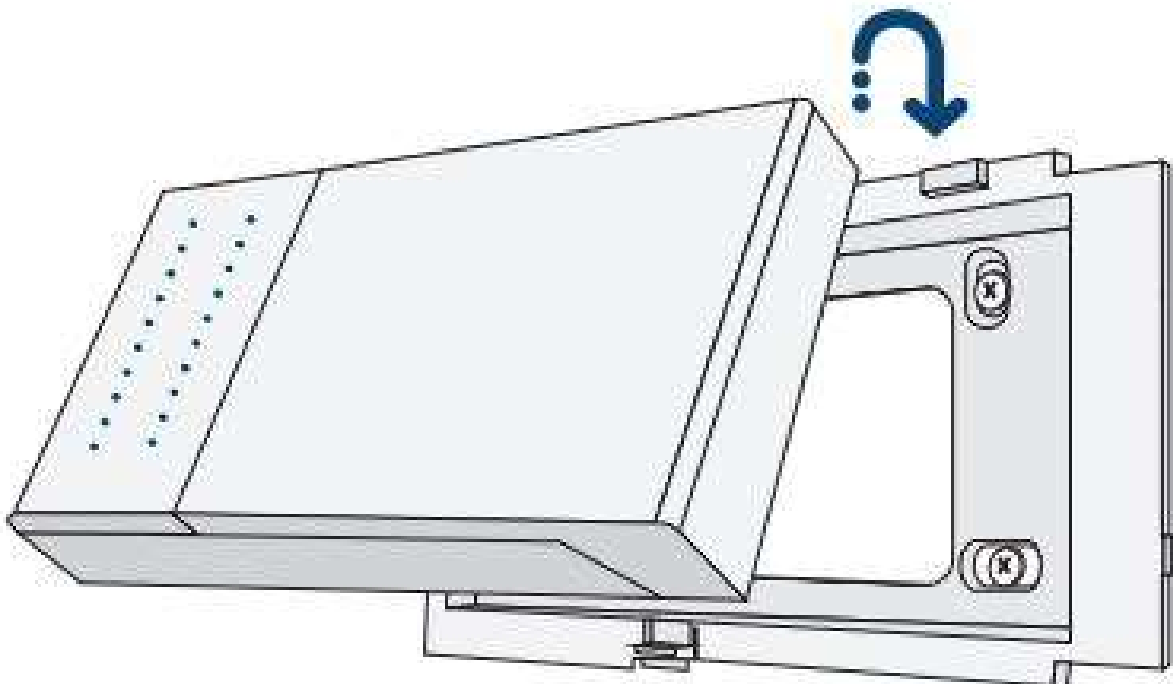

6

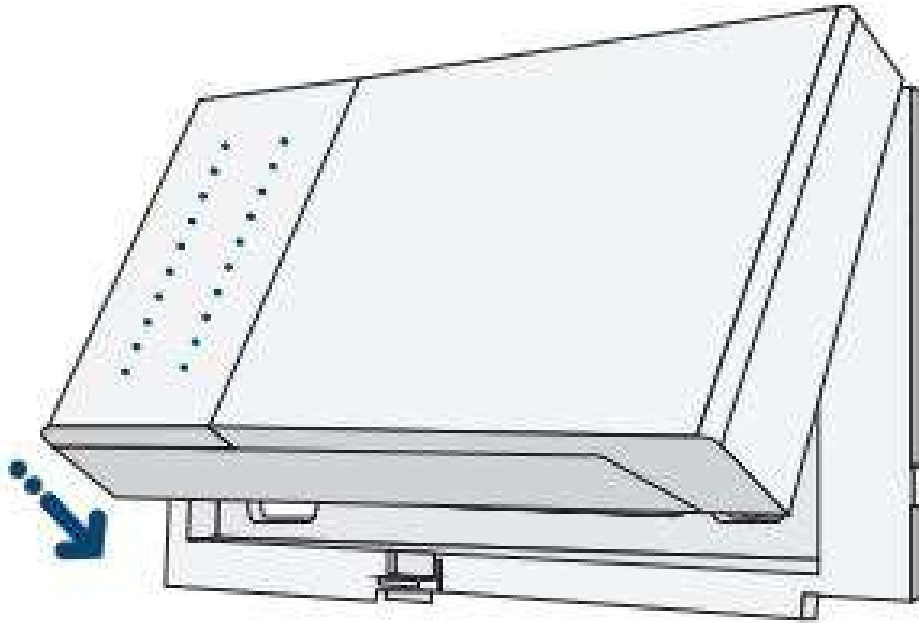

7

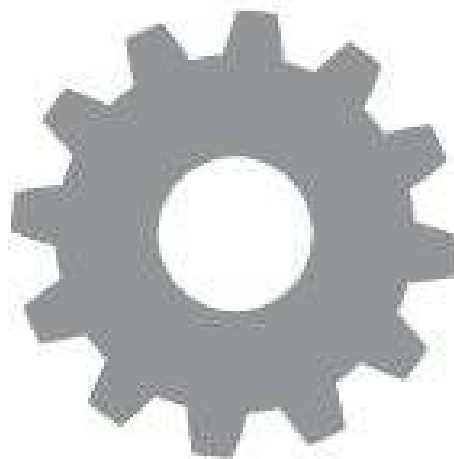

ELDES
Configuration Tool

FRONT

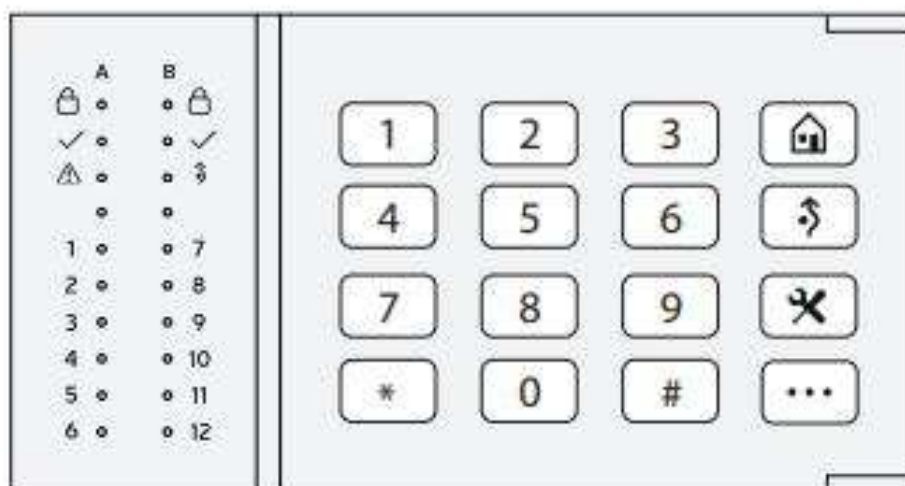



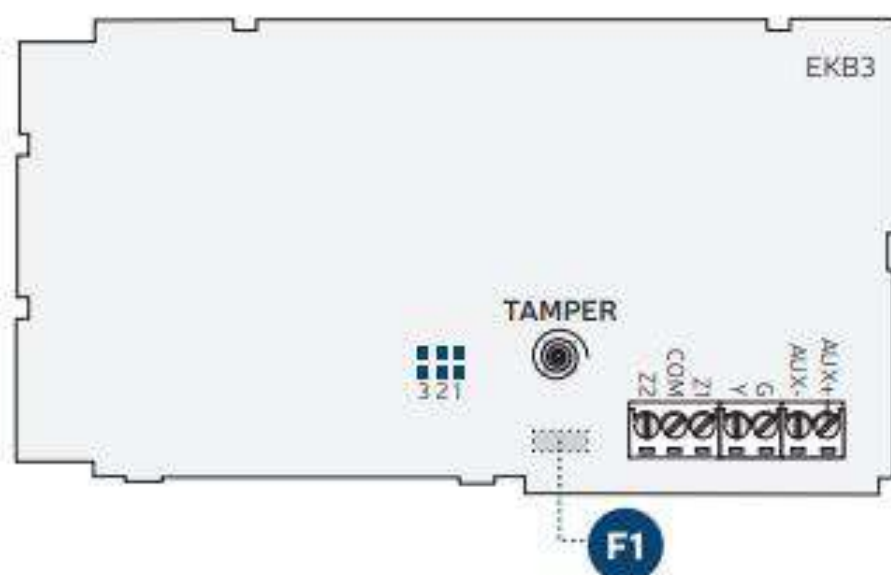



BACK





	DESCRIPTION
F1	Fuse model MINISMDC020F-2 0.2A
Z2	N/A
COM	Common terminal
Z1	Zone terminal
Y	RS485 interface data bus terminal (yellow wire)

	DESCRIPTION
G	RS485 interface data bus terminal (green wire)
AUX-	Negative power supply terminal
AUX+	Positive power supply terminal
3, 2, 1	Keypad address pins
TAMPER	Switch for enclosure state supervision

	DESCRIPTION
	1st character for STAY-arming
	1st character for violated zone bypass and bypassed zone activation
	1st character for Configuration mode activation or deactivation (only for ESIM364 v02.07.00 and up)
	1st character for system fault list indication / 1st character for violated high-numbered zone indication / 1st character for violated tamper indication
0 - 9	Command typing
	Keypad partition switch (only for ESIM364 v02.07.00 and up)
	LED indication
1 - 4	Steady ON: partition armed (only for ESIM364 v02.07.00 and up) Flashing: partition violated (only for ESIM364 v02.07.00 and up)
0	Simultaneous 4-partition arming (only for ESIM364 v02.07.00 and up)

	DESCRIPTION
	1st character for Configuration mode activation and deactivation (for ESIM364 up to v02.06.20; ESIM264 all versions) / 1st character for keypad partition switch (if enabled; only for ESIM264) / clear typed in characters
	Typed in command confirmation

	INDICATION	DESCRIPTION
 (red)	Steady ON	System armed / exit delay in progress
	Flashing	Configuration mode activated
 (green)	Steady ON	System is ready – no violated zones and/or violated tampers exist
	Steady ON	System faults exist
 (orange)	Flashing	Violated high-numbered zone
	Steady ON	Violated zone bypassed
1-12 (red)	Steady ON	Zone violated / configuration command being typed in

2. KEYPAD ADDRESS

ELDES alarm system supports up to 4 EKB3 keypads, each individually addressed. The keypad address is set by physically changing the jumper position on the pins located on the back side of the keypad

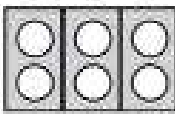
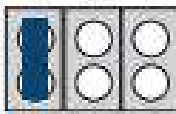
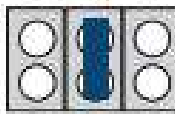
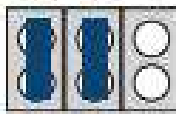
JUMPER COMBINATION	3 2 1	3 2 1	3 2 1	3 2 1
				
ADDRESS	Keypad #1	Keypad #2	Keypad #3	Keypad #4

Alternatively, the keypad address of the connected keypad can be viewed using ELDES Configuration Tool software.

5. TECHNICAL SPECIFICATIONS

Compatible with:

- ESIM364 v02.06.01 and up.
- ESIM264 v07.14.02 and up

Supply voltage	12-14V == 100mA max
Zone connection type	NC (normally-closed) / NO (normally-open)
Maximum supported wire length	100 m (328.08ft)
Range of operating temperature	-30...+55°C (-22... +131°F).
Humidity	0-90% RH @ 0... +40°C (0-90% RH @ +32... +104°F)
Dimensions	145x80x31mm (5,71x3.15x1.22in)