

Installation instruction

Intelligent Outdoor Detector With 2 x PIR+MW

1. INTRODUCTION

OTD-40T is a special three-tech (PIR+PIR+MW) detector for outdoor intrusion protection. Signals of 3 sensors are with super stability and dependability by its advanced multi-grades digital signal processing technology. And they can offer 3 different detection modes on 2 sensitive grades in order to choose the best detection way for spot environment and gets the best rate between the best detection ability and the minimum false alarm rate. With normal "AND" and "OR" modes, OTD-40T detector is also with "EI" mode to avoid the damage of dopes spraying on the lens. Its unique water-proof design is totally fit for outdoor installation. At the same time, OTD-40T is also with other functions such as anti-mask automatic setting and alarm type memory etc.

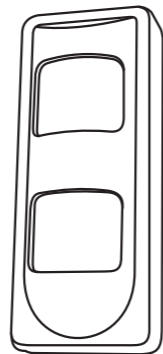

Figure 1

2. BRIEF INTRODUCTION

- *Two PIR and MW detection tech
- *Automatic setting of anti-mask
- *Microwave synchronization
- *Detection mode: AND/OR/EI
- *Selectable detection sensitivity
- *Alarm type memory
- *Anti white light
- *Pet immunity $\geq 25\text{kg}$

- *Alternative Led OFF
- *Micro-strip MW with pulse transmission
- *18 beams Fresnel lens with down-view window on its 4 planes
- *Vertical adjustment
- *Air-proof optical parts
- *Wall inlay
- *Total view: 90° , Monitoring scale: 15m
- *Corner and wall installation. Universal connector
- *Universal connector for option,
- * 90° horizontal adjustment 30° vertical adjustment

3. SPECIFICATIONS

Power supply: 9-16VDC
 Current: 30mA
 Install high: 1.5m.-2.4m
 MW frequency: 10.525GHz
 Alarm time: 3s
 Anti RFI/EMI: 0.1-500MHz/3V/m
 Anti-white light: >10000LUX
 Alarm output: 100mA/24V
 Mask output: 100mA/24V
 Temperature: $-10^\circ\text{C}/+55^\circ\text{C}$
 Humidity(RH): 95%
 Sensitivity: H / L Select
 Detect speed: 0.2m/s to 3.5m/s
 Dimensions (H*W*D): 160mm*65mm*50.5mm

Coverage:

12m*12m	100° (wide lens)
12m*3m	12° (curtain lens)
12m*12m	100° (pet lens)

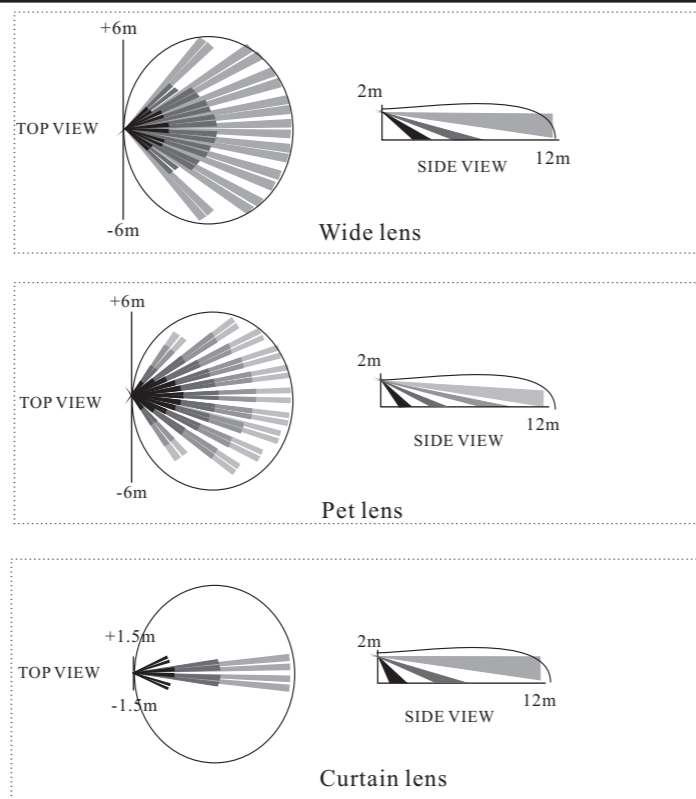

Figure 2

4. INSTALLATION GUIDE

Select the best installation point fit for PIR and MW technologies. Put OTD-40T onto the selected place and keep it away from door, window, running machine or heat sources.

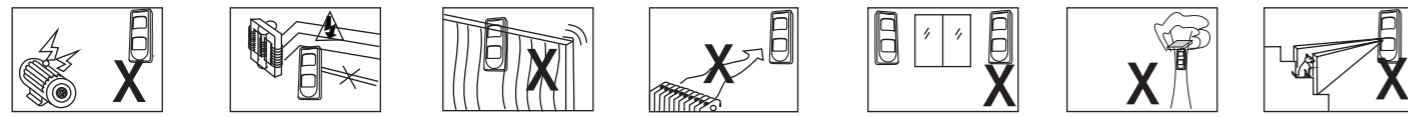

Figure 3

5. WALL FASTENING

In order to get the best signal covering scale, detector should be installed on 2.1m height and vertical adjustment to position A. Anyhow, detector can be installed to maximum 4 m height. Make sure that there are no counterwork in front of the detector and it is with a wide view.

Remove the front cover, release the screws and then pull out the PCB. Break the pre-set hole, (Figure 6), if necessary, disclose the "wall inlay pre-set hole" and tear open once "wiring hole"; mark the point of the hole on wall and put the "wall inlay" label on the pre-set hole. Drill 3 holes with 6mm and screw in the "wall inlay screws", let its front extremity be 5/6 mm from the wall. Cross the wire from the cable hole and fasten the bottom cover onto the wall, confirm its front extremity enter the obligate site.

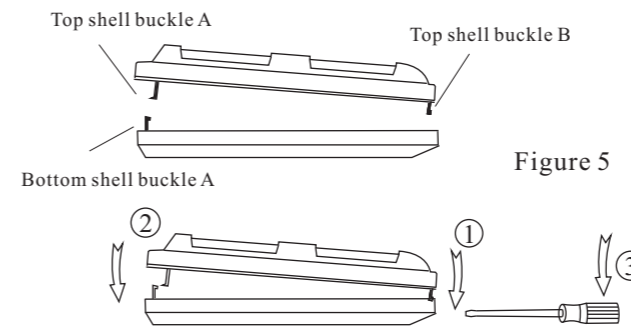

Figure 5

Procedure for closing the cover:

1. Face the B knob of upper cover to the slot of lower cover, and face A knob of upper cover with A knob of lower cover, press it down and then the covers can be closed.
2. Fasten the screw.

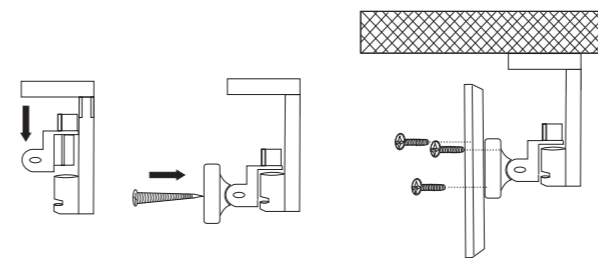

Figure 7

First to fasten the wall mount accessory onto the proper main body for installation, and then insert twist and connection accessories, finally install the bottom cover of detector

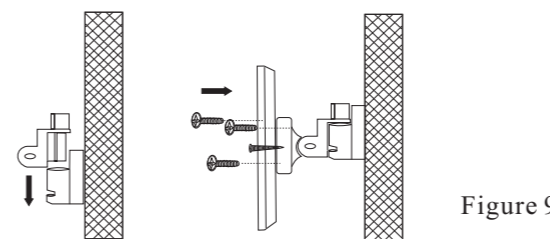

Figure 9

First to fasten the corner mount accessory onto the proper main body for installation, and then insert twist and connection accessories, finally install the bottom cover of detector

6. PART EXPLAIN

(Refer to the left diagram)

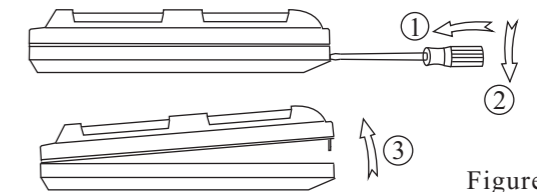

Figure 4

Procedure for opening the cover:

Refer to 1 and 2 in the pictures release the screw on the external cover; and refer to 3 to open the two covers gently.

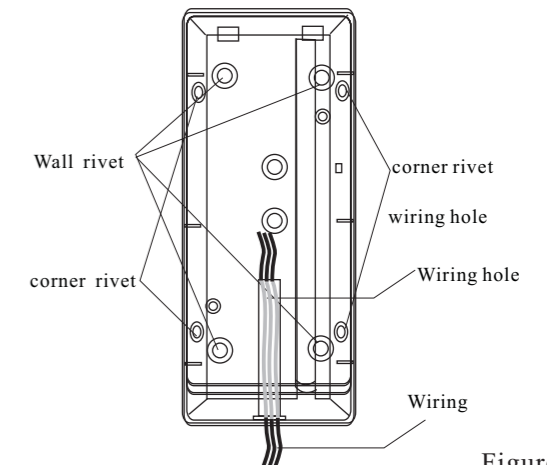

Figure 6

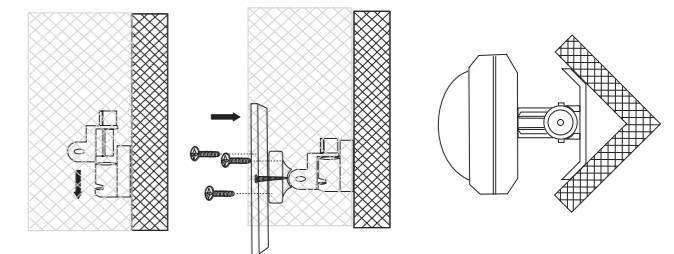

Figure 8

First to fasten the ceiling mount accessory onto the proper main body for installation, and then insert twist and connection accessories, finally install the bottom cover of detector

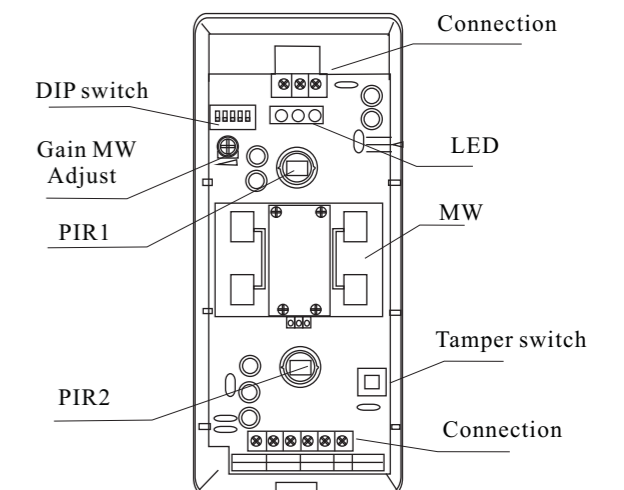

Figure 10

7. TESTING

DIP 1 switch on [OFF] (anti mask cover [OFF])
 DIP 5 switch on [OFF] (LED actives)

Note**
 During this mode, anti-mask is limited.

MW

Tune microwave tuner to minimum, (capacity can be adjusted from 2-15m) to the extremity of protection area when LED indicator turns off operation radial movement to the detector, check MW detection by green LED. If green LED doesn't light, turn the MW tuner in clock wise to increase its capacity; repeat this tests for several times till you get the required distance. Remarks: MW adjustment turn the capacity to the minimum, for MW can penetrate wall while over high capacity is not helpful for detector function in its protection area. (MW gets highest sensitivity when it performs radial movement to detectors)

PIR

Close the front cover, when LED indicator turns off, perform horizontal movement in the detection area, check the detection status of PIR through the yellow LED. This step can check whether there is deal corner in the detection area; when PIR gets highest sensitivity when horizontal movement to detector. When all DIP switches are in [OFF] status, monitor is in standard operation.

Anti-mask cover control /AND/ high sensitivity /LED activation

If want to get max. monitoring, please refer to [monitoring mode] section.

Note** When there is interference to the monitor, anti-masking cover function will be limited.

Time	9	10	11	12	1	2	3
Range	2m	4m	6m	8m	10m	12m	14m

Figure 11

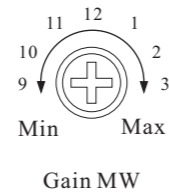

Figure 12

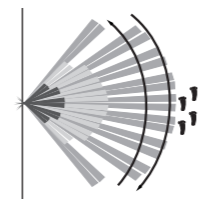

Figure 13

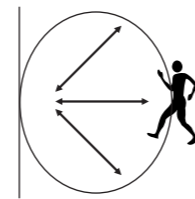
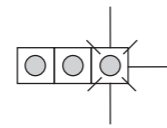
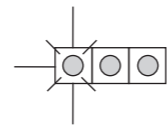

Figure 14



Yellow led

Figure 15



Green led

Figure 16

8. MONITORING MODE

AND

DIP 2 switch on "OFF" status
 If three sensors (2*PIR&MW) get the detection signal at the same time, alarm will be trigger. This mode is fit for installation with unstable factors.

OR

DIP 2 switch in "ON" position
 Any of the sensors gets detection signal, alarm will be triggered. This mode is fit for high stable environment and inquires the detector with very high detection ability.

EI (MODE)

DIP 3 switch is in "ON" position
 During the status, DIP 2 switch is useless.
 If three sensors get the detection signal at the same time, (such as AND mode), or if it they gets more MW signal while there isn't any 2*PIR signal, alarm conditions are provided. Fit for the installation which needs "AND" detection mode, but it may exist PIR shadow area, or somebody spray the dope onto the PIR lens willfully to damage the PIR detection.

SENS L

DIP 4 switch is in "ON" position
 Detection sensitivity of both sensors are reduced.

PIR: During the time, signals detected by both negative and positive period of PIR are limited.

MW: the detection response speed of MW is 0.5 seconds, running speed is 0.6m/second.



Figure 17

1	2	3	4	5
ON	MASK	OR	EI	SEN L
OFF	AND	SEN H	LED	

Figure 18

ALARM	Green Led	Red/Blue Led	Yellow Led
PIR+MW	OFF	ON	OFF
PIR	OFF	ON	ON
MW	ON	ON	OFF
MASK	FLASH	FLASH	FLASH

Figure 19

9. FUNCTION

Anti-mask function

Anti object block the MW may cause alarm by the twinkle of LED indicator, and the signal is transported to monitoring center by MASK connector. Alarm status will last till the causes of formation are cleared away.

Activation of anti-mask function

DIP 1 switch is in "ON" position
 The activation of anti-mask function is the final operation. After activation, OTD-40T enters self-check status; during the time, LED indicator will twinkle for 100 seconds. During the time, close the front cover and keep away from the detector, detector will enter automatic setting status and perform automatic adjustment of the height of antimask cover. The most important point is, during the time, there isn't anything approaching the detector to avoid its automatic setting.

LED OFF

DIP 5 switch
 In "ON" position, it will limit detection display. When connect INHIBIT cable or pulling out the equipment, detector will start its display for 30 seconds after the first detection.

MW OFF

DIP 1 switch is in "OFF" position
 DIP 5 switch is in "ON" position

Note**
 During this mode, anti-masking is limited.

When LED indicator is in "OFF" mode, anti-masking function is limited. INHIBIT is connected, monitoring center is broken, LED indicator doesn't activate, MW turns off to avoid radiation to the protection area.

Relay control

When INHIBIT is connected, monitoring center is broken, alarm relay is under limitation mode.

Memory

When INHIBIT is connected, equipment is disconnected and the first alarm will be displayed. (see figure 19). When equipment is reconnected, memory will be set again.

10. WIRE UP THE TERMINAL

TAMPER The contact is closed normally, if remove the front small cover or the whole detector from the wall, contact will open. (sensor connects with wall in lay style monitor)

DC DC:9-16V / 30mA

ALARM Alarm output is close normal and its contact will open during alarm.

P INHIBIT: recognition input for plug in/draw out. +12 tands for recognition of equipment drawing out.

MASK Anti masking cover output contact is closed when it is normal.

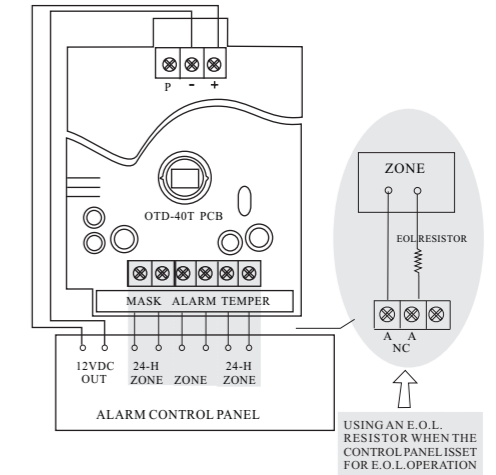

Figure 20

11. VERTICAL ADJUST

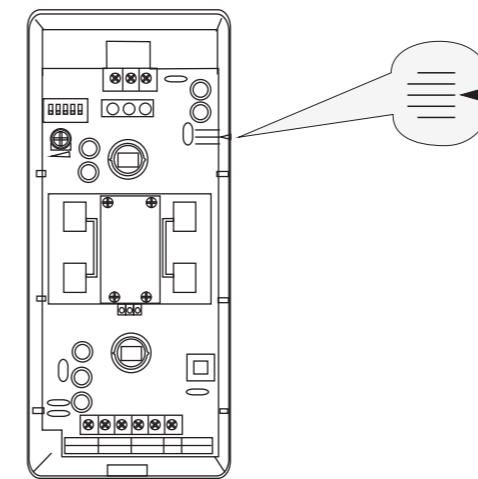
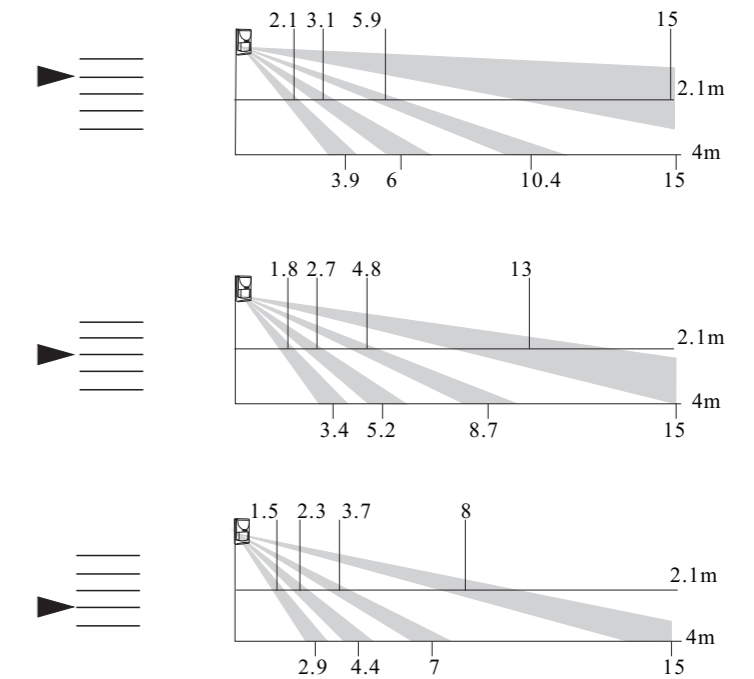

Figure 21



12. NOTES AND WARNINGS

Even the most sophisticated detectors can sometimes be defeated or may fail to warn due to :DC power failure/improper connection, malicious masking of the lens,tampering with the optical system, decreased sensitivity in ambient temperatures near that of the human body and unexpected failure of a component part. The above list includes the most common reasons for failure recommended that the detector and the entire alarm system be checked weekly, to ensure proper performance. An alarm system should not be regarded as a substitute for insurance. Home & property owners or renters should be prudent enough to continue insuring their lives & property, even though they are protected by an alarm system.

WARNING! Changes or modifications to this unit not expressly approved by the party responsible for compliance could void the user's authority to operate the equipment.

This device has been tested and found to comply with the limits for a Class B digital device, pursuant harmful interference in residential installations. This equipment generates,uses and can radiate radio frequency energy and ,if not installed and used in accordance with the ins-tructions ,may cause harmful in-terference to radio and television reception. However, there is no guarantee that interference will not occur in a particular installation. If this device does cause such interference , which can be verified by turning the device off and on ,the user is encoura-ged to eliminate the interference by one or more of the follow ingmeasures:

- Increase the distance between the device and the receiver.
- Connect the device to an outlet on a circuit different from the one that supplies power to the receiver.
- Consult the dealer or an experienced radio/TV technician.